

Aquauno Video 2



US

03

ES

29

FR

55



8428

claber®

Table of contents

US

<i>Introduction</i>	4
<i>Features</i>	5
<i>Operating controls</i>	6
<i>Operating tips</i>	7
<i>Battery installation</i>	8 - 9
<i>Installation on faucet</i>	10
<i>Display and keyboard</i>	11 - 13
<i>Programming</i>	14 ➔ 20
<i>Setting current time</i>	14
<i>Setting programs</i>	15
<i>Deleting programs</i>	16
<i>Default factory settings</i>	16
<i>Weekly schedule</i>	17 - 19
<i>Manual mode</i>	20
<i>Frequently asked questions</i>	21
<i>Trouble shooting</i>	22 - 23
<i>Routine maintenance</i>	24
<i>Parts blowout drawing</i>	25
<i>Technical specifications</i>	26
<i>Disposal (WEEE)</i>	26
<i>Warranty</i>	27 - 28
<i>Declaration of conformity</i>	28

Symbols adopted in the manual



important
note



additional information

US Introduction

We are pleased you have chosen the Aquauno Video2 water timer, model 8428. This Italian-made timer utilizes the most sophisticated technology and most durable material bringing you years of low maintenance and a worry-free lawn. Read instruction manual carefully before programming and keep it handy for future reference; each section will provide all the necessary information on how to perform the single steps correctly.

This appliance has been designed and manufactured exclusively for programming irrigation systems and is intended for use by competent and experienced adults. Any other use is considered improper; the manufacturer acknowledges no liability for damages arising from improper use and will not recognize claims under Warranty for such damages.

If you have any questions regarding this water timer, please call our toll free customer service line at 800-930-4566 or email us at info@claberinc.com.

Features

The water timer allows to easily set day, time and duration of the watering cycles, meeting any kind of need for plants with different watering requirements, depending on species and environmental situation.

The timer is powered by one 9V Alkaline battery (not included) that must be replaced at the beginning of the watering season and that will last for at least one full season.

- Timer is programmable to release water up to 2 times a day for duration ranging from 1 minute to 23 hours and 59 minutes.
- Watering cycles can be programmed in advance and open consecutively starting from program 1.
- Weekly function is included; both programs run on any or all days of the week.
- 15 Minute preset manual mode allows to water between cycles or to pause them without altering settings.
- Programs are retained while battery is being replaced.
- 3/4" Female faucet connector with washable stainless steel filter.
- Quick-click® coupling included for fast and easy hose removal.
- Power supply: one 9V Alkaline battery.
- Operating pressure: 2.9 - 145 PSI (0.2 - 10 Bar).

US Operating controls

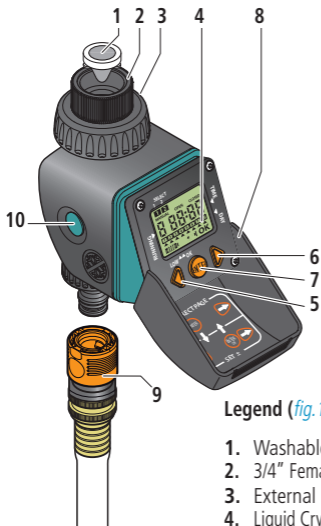

Legend (fig. 1):

1. Washable stainless steel filter
2. 3/4" Female faucet connector with O-ring
3. External ring nut
4. Liquid Crystal Display (LCD)
5. Backward button
6. Forward button
7. Enter button
8. Protective cover
9. Male quick-click® connector
10. Opening side buttons

fig. 1

Operating tips

- Use Alkaline batteries only; do not use lithium or rechargeable batteries.
- Install a new battery at the beginning of the watering season.
- Regularly wash the filter to prevent clogging.
- Remove from faucet when temperature reaches below 37.4°F (3°C), drain all water and remove battery to avoid oxidation.
- When using for the first time, observe the progress of the program/s to ensure the unit operates properly.
- Be careful when pulling the hose or fittings to prevent damage to the unit.
- Do not use with operating pressure below 2.9 PSI (0.2 Bar) or higher than 145 PSI (10 Bar) and with water temperature exceeding 104°F (40°C).
- Do not install into any type of valve box or under the soil level.
- Do not submerge in water or other liquids.
- Do not let the housing and the internal parts of the timer come into contact with chemicals such as harsh detergents, chlorine, fertilizers, etc.
- Keep the cover closed when not programming to protect against outdoor elements.



- **Keep out of reach of children and animals.**
- **Do not expose at temperature below 37.4°F (3°C).**

US Battery installation

To install or replace the battery, proceed as follows (*fig.2*):

- Press the two side buttons on the black housing simultaneously (1) to release the front panel (2).
- Insert new 9V Alkaline battery (3) and position the battery into holder (4).
- Slide front panel back into the housing, ensuring side buttons click into place (5).

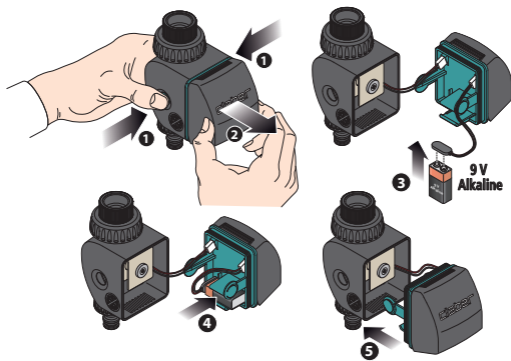





fig.2

Battery installation

Notes:

- Use only new Alkaline batteries.
- Replace the battery at the beginning of the watering season.
- Timer is protected against reverse polarity of the battery and automatically checks the battery level; battery charge indicator flashes when battery is running low to indicate that battery should be replaced.

Indicator of battery charge				
Charge status	Battery fully charged	Battery partially charged	Run-down battery to be replaced	Dead battery to be replaced

- When battery is dead, the timer will automatically shut off all functions and close the valve.
- When replacing the battery, the clock time and the current date in addition to the irrigation times are stored for a maximum of 30 seconds. Beyond this period of time, the following must be reset:
 - current time (*see "Setting current time", page 13*);
 - weekly schedule of watering (*see "Weekly schedule", page 17-19*).
- Timer is equipped with a safety feature that prevents the opening of the valve if the battery does not have enough power to ensure the valve to close.
- When timer is not in use for an extended period of time, remove the battery to avoid oxidation.
- Do not dispose dead batteries as ordinary household refuse: always replace batteries properly, according to local ordinances.

US Installation on faucet

Attach the timer to a water tap, following these simple instructions (fig.3):

- 1 Tap should have a 3/4" male thread (if not, use an adaptor).
- 2 Screw the 3/4" female faucet connector onto the tap by turning counterclockwise.
- 3 Position the timer in the proper direction and tighten clockwise the external ring nut by hand only without using any kind of tool.
- 4 Screw the male threaded hose end connector into the garden hose and push the quick-click® connector onto the timer.



- Do not install into any type of valve box, underground or indoors.
- Use with tap water only.
- Do not use with operating pressure below 2.9 PSI (0.2 Bar) or higher than 145 PSI (10 Bar) and with water temperature exceeding 104°F (40°C).

Display and keyboard

DISPLAYING THE PAGES

Buttons ◀ and ▶ allow you to scroll through the various programming pages.

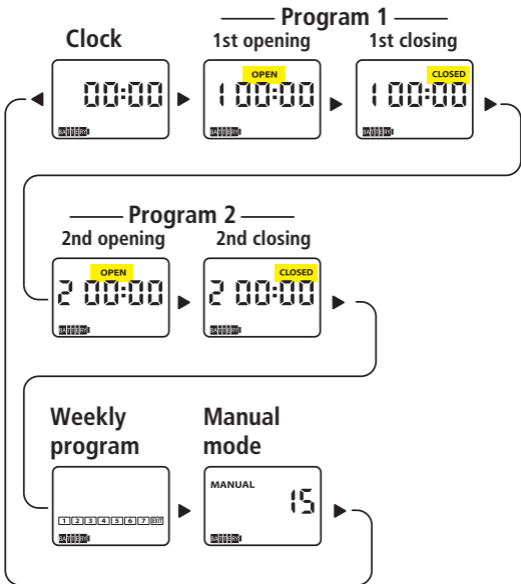

US Display and keyboard

DISPLAY

Number indicates that program 1 and/or 2 is active. If number blinks, indicates that program 1 or 2 is running at that moment and timer is watering

On programming pages, indicates time of OPEN=start of the program, CLOSED=end of the program
On Manual mode, indicates status of the valve: OPEN or CLOSED

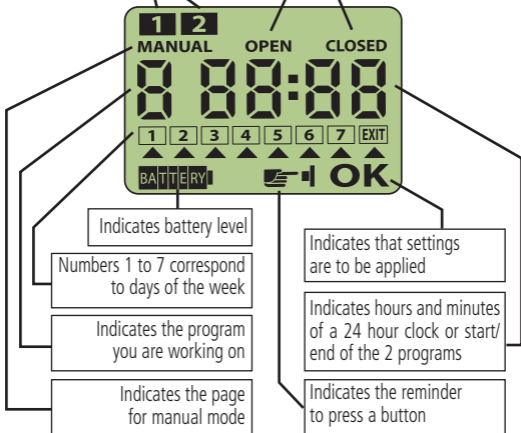

Display and keyboard

KEYBOARD

Only three keys let you set all the parameters.

The buttons ◀ and ▶ let you scroll through the different pages, increase/decrease the time of the clock and the time of the programs as well as open/close the valve in the manual mode.

The ENTER button lets you access the EDITING of the parameter displayed. When pressing the ENTER button, **OK** appears in the bottom right side of the display.

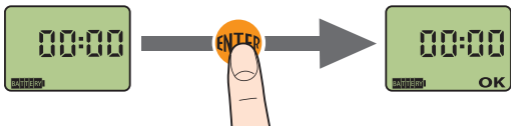

At this point, parameters can be edited by using the ◀ and ▶ buttons; if ◀ and ▶ buttons are not pressed for 10 seconds, the ⚡ flashing symbol appears on the screen to remind you to press a button to continue with the editing.

When programming, if after 5 minutes the ENTER button is NOT pressed, data is not stored and will automatically return to the clock page.





US Programming

SETTING CURRENT TIME

As soon as the battery is connected, you will hear a click indicating that valve is closed for safety purposes and immediately the display will turn on showing the clock page as 00:00.

1 Press  and **OK** appears.



2 Press the  or  buttons to increase or decrease the current time. By holding down the button, the time progresses more quickly until the required time is reached. Timer works on a 24 hour clock (i.e. 2 pm=14:00) therefore refer to the military hours chart below:

REGULAR TIME											
noon	01:00	02:00	03:00	04:00	05:00	06:00	07:00	08:00	09:00	10:00	11:00
	PM	PM	PM	PM	PM	PM	PM	PM	PM	PM	PM
↓	↓	↓	↓	↓	↓	↓	↓	↓	↓	↓	↓
12:00	13:00	14:00	15:00	16:00	17:00	18:00	19:00	20:00	21:00	22:00	23:00
MILITARY TIME											















3 To confirm the edited time setting, press .



Programming

SETTING PROGRAMS

When setting the programs, make sure that your schedule falls within a single 24 hour window (i.e. 00:01 - 23:59). Program 1 must correspond to your earliest watering cycle of the day.

- 1 Press  to display the page of **PROGRAM 1** in the **OPEN** status.
- 2 Press ; **OK** appears to edit the opening time of the program.
- 3 Use  and  to decrease or increase the opening time. On the upper left side of the display appears 1 as numbered digital block to indicate that program 1 is active. This numbered digital block flashes when program is in operation. By holding down  or  time progresses more quickly.
- 4 Press  to confirm the edited opening time, **OK** disappears.
- 5 Press the  button to display the page of the **PROGRAM 1** in the **CLOSED** status.
- 6 Press ; **OK** appears to edit the closing time of the program.
- 7 Use  and  to set the closing time (**CLOSED** status).
- 8 Press  to confirm the edited closing time, **OK** disappears.
- 9 Press the  to display the page of **PROGRAM 2** in the **OPEN** status.

Follow the instructions listed above to set opening and closing time of **PROGRAM 2**.



Programs must be set in sequence, therefore Program 2 can not be set if Program 1 has not been stored.



When programming watering cycles, time automatically adjusts by default to the next minute (i.e. Program 1 closing time is 07:30, Program 2 opening time defaults to 07:31).

US Programming

DELETING PROGRAMS

It is possible to cancel a program previously set.

- 1 Select the **CLOSED** page of the program that you wish to cancel.
- 2 Press **ENTER**; **OK** appears.
- 3 Press both **◀** and **▶** buttons until display reads 00:00 and the number corresponding to the program (1 or 2) located on the upper left side of the display is no longer shown.

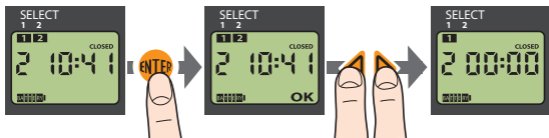

DEFAULT FACTORY SETTINGS

On any page, hold down for approximately 10 seconds the **◀** and **▶** buttons until display shows 00:00.



Programming

WEEKLY SCHEDULE

1 Before setting the weekly schedule, it is necessary to know on which day the timer has been set for the first time. Press ◀ or ▶ to display the time clock page. The number located above the battery indicator symbol corresponds to "TODAY".

2 Use the ◀ or ▶ to move through the pages until the display shows the weekly schedule where numbers 1 to 7 represent the days of the week. Use the table below to determine the correspondence between the numbers and the week days.

		TODAY													
		M	T	W	T	F	S	S	M	T	W	T	F	S	S
		↓	↓	↓	↓	↓	↓	↓	↓	↓	↓	↓	↓	↓	↓
W E E K		1	2	3	4	5	6	7							
			1	2	3	4	5	6	7						
				1	2	3	4	5	6	7					
					1	2	3	4	5	6	7				
						1	2	3	4	5	6	7			
							1	2	3	4	5	6	7		
								1	2	3	4	5	6	7	
									1	2	3	4	5	6	7

Look for your current day on the **TODAY** row of the chart (M=Monday, T=Tuesday, W=Wednesday, etc.). At this point, look down on the **WEEK** column to individuate the number previously displayed on the clock page. The row in which that number is located provides the correspondence between the numbers and the week days.

US Programming

WEEKLY SCHEDULE

EXAMPLE:

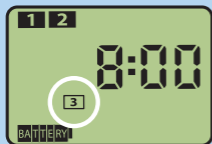

Today is Saturday and the water timer shows **3** as the current day on the clock page.

Consult the table and look for the current day (Saturday) in the TODAY row.

On Saturday, go down the WEEK column until you find **3** → the row in which the number is found provides the correspondence between the numbers and the days of the week: **1** = Thursday, **2** = Friday, **3** = Saturday, **4** = Sunday, **5** = Monday, **6** = Tuesday, **7** = Wednesday.

		TODAY													
		M	T	W	T	F	S	S	M	T	W	T	F	S	S
		↓	↓	↓	↓	↓	↓	↓	↓	↓	↓	↓	↓	↓	↓
WEEK	1	1	2	3	4	5	6	7							
	2		1	2	3	4	5	6	7						
	3			1	2	3	4	5	6	7					
	4				1	2	3	4	5	6	7				
	5					1	2	3	4	5	6	7			
	6						1	2	3	4	5	6	7		
	7							1	2	3	4	5	6	7	
	8								1	2	3	4	5	6	7

Programming

WEEKLY SCHEDULE

- 3** Select which days of the week you will be watering:
- Press **ENTER** to edit the settings; **OK** appears.
 - Press **◀** or **▶** to move the cursor under the number (=day of the week) you want to change the setting.
 - Press **ENTER** to deactivate or activate the watering on the day selected. Number visible means day activated for watering, number not visible means day not activated for watering.
 - Once settings are confirmed, align the cursor under **EXIT** and press **ENTER**.

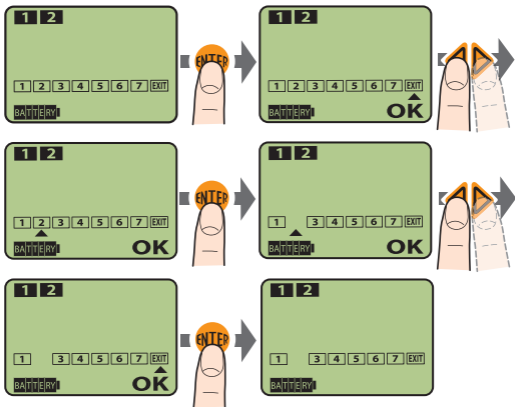

US Programming

MANUAL MODE

The manual mode page can be accessed by pressing the ◀ button on the clock page or the ▶ button on the weekly schedule page.

- 1 When on **MANUAL** mode page, press **ENTER**; **OK** appears on the right side bottom of the display and **CLOSED** shows above number 15.

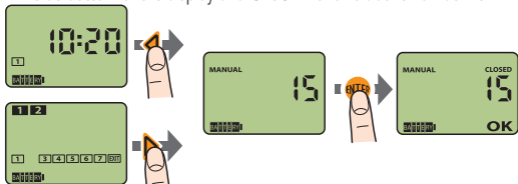

- 2 Press the ◀ button to **OPEN** the valve and start watering. Manual watering is automatically preset at 15 minutes; at the end of the watering, valve will close automatically.

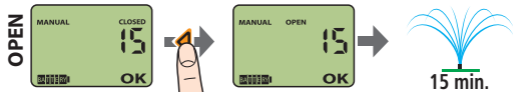

- 3 Press the ▶ button to stop watering at any time.



- 4 To exit from the manual mode, press **ENTER** when valve is in the **CLOSED** position.

Frequently asked questions

1

Can the programs be scheduled to operate on any specific week day?

No, all programs must be set within a 24 hour window starting from midnight = 00:00.

2

When on the current time page, what does the small number in the clear box on bottom of the screen represent?

It represents the day of the week the timer is operating on; please refer to example on page 18.

3

Can I change the 15 minute of the manual mode?

No, digital setting is preset to avoid possible flooding when the unit is not supervised during the manual mode. Altering the manual function can be executed by hand selection only.

4

What happens if the unit is not removed during freezing temperature?

The ABS plastic components will crack causing the unit to be inoperable.

5



How do I determine the time in military hours?

Use chart below as a reference:

REGULAR TIME											
noon	01:00 PM	02:00 PM	03:00 PM	04:00 PM	05:00 PM	06:00 PM	07:00 PM	08:00 PM	09:00 PM	10:00 PM	11:00 PM
12:00	13:00	14:00	15:00	16:00	17:00	18:00	19:00	20:00	21:00	22:00	23:00
MILITARY TIME											

US Troubleshooting

The following table provides useful instructions for safely dealing with possible malfunctions that you might encounter during the use of the watering system.

PROBLEM	SOLUTION
The timer does not work (display turned off)	<i>Battery is dead or has not been fitted correctly (see "Battery installation", page 8 - 9).</i>
	<i>Timer is faulty: contact CLABER INC. customer service line at 800-930-4566 or email info@claberinc.com</i>
The timer works (display on) but does not water as programmed	<i>No water supply: inspect and restore.</i>
	<i>Check:</i> <ul style="list-style-type: none">- <i>the status of the filter and clean it if necessary (see "Routine maintenance", page 24);</i>- <i>the correct connection of the watering line.</i>
	<i>Contact CLABER INC. customer service line at 800-930-4566 or email info@claberinc.com</i>
The timer does not work properly	<i>Factory settings can be restored by pressing and holding down for approximately 10 seconds both  and  until display reads 00:00. Then, reprogram the timer (see "Setting current time", page 14 and "Setting programs", page 15-20).</i>

After battery replacement, programs take place at times and/or days different from those previously set.

When replacing the battery, the clock time and the current date in addition to the irrigation time are stored for a maximum of 30 seconds.

Beyond this period of time, the following must be reset:

- *current time (see "Setting current time", page 14).*
- *weekly schedule of watering (see "Weekly schedule", page 17-19).*

US Routine maintenance

- Periodically, check and clean the filter under running water (see [fig.4](#)).
- Clean impurities inside and outside the unit using a soft cloth moistened slightly with water. Do not use abrasive pads or scourers, or detergents with a high acid content.
- Check that all wires are in good condition.

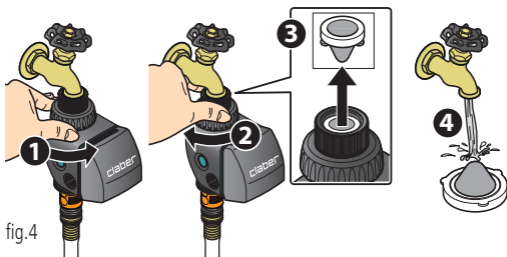

fig.4



During winter, and/or when the timer is not in use, always remove the battery and store in a dry place at a temperature no lower than 37.4°F (3°C).



Disassembly or tampering of the unit by unauthorized personnel voids the Warranty.

Parts blowout drawing

US

Description

1. 1-1/4" External ring-nut
2. Stainless steel filter
3. 3/4" Female faucet connector
4. NBR O-ring
5. Valve body
6. O-ring
7. 1/2" Female connector
8. Screw M4x8
9. Spacer for solenoid
10. Bracket
11. Screws (x4) for magnet flange
12. Magnet group with bushing and flange*
13. Piston
14. Membrane valve
15. Solenoid with upward cable**

* white side of the magnet must be UPFRONT

** wire cable must be UPWARD

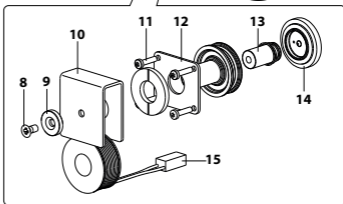
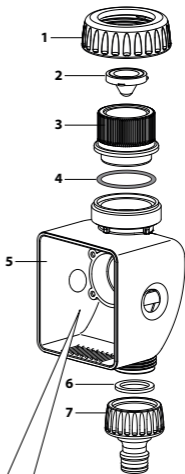

US Technical specifications

Power supply:	1 x 9V Alkaline battery
Average life of battery:	1 year
Ingress protection:	IP 20
Operating temperature:	37.4°F - 104°F (3°C-40°C)

Operating pressure:	MAX: 145 PSI (10 Bar) MIN: 2.9 PSI (0.2 Bar)
---------------------	---

Plastic materials:	>ABS< >PC< >POM< >TPE<
--------------------	---------------------------------

Disposal (WEEE)



The symbol in question applied to the product or the packaging indicates that the product must not be considered as ordinary household refuse, but must be disposed according to local ordinances for the collection and recycling of waste electrical and electronic equipment.

Warranty

US

Product is warranted for a period of 2 years from date of purchase with proof of purchase.

Claber, at its own discretion, will repair or replace defective parts of the unit if operated under normal working conditions.

The warranty is void in the event of:

- Lack of physical proof of purchase (invoice or receipt).
- Use or maintenance different from what is specified in this manual.
- Disassembly or tampering by unauthorized personnel.
- Faulty installation of the product.
- Damages from atmospheric agents (e.g. temperature lower than 37.4°F /3°C)
- Damages from chemical agents (e.g. chlorine, fertilizer, etc.).

Claber shall not be liable for damage on products manufactured by other companies when combined in use.

Claber, at its own discretion, may require product or parts to be returned to the Warranty Department. All shipping charges and risks are incurred by customer.

If coverage is found, product or parts will be repaired or replaced. Please allow 3-4 weeks to process return.

All repairs or replacements are warranted only for the remainder of original warranty period, started at date of purchase.

Charges may incur if warranty coverage is not applicable.

US Warranty

To ensure warranty coverage, serial number (i.e. 986 1383, located inside green face plate identified by 7 or 8 digit code) and a copy of sales receipt should be sent within 30 days after purchase in one of the following ways:

1. MAIL

Claber, Inc
191 Stanley Street
Elk Grove Village, IL 60007

2. FAX

Fax: 847.364.4588

3. EMAIL

info@claberinc.com

WRITE THE SERIAL NUMBER

--	--	--	--	--	--	--	--

Please note that if above information is not on file at time of contact, this may cause delay or refusal of warranty fulfillment. For any further information on customer assistance, you may contact Claber Inc. at toll free 1-800-930-4566.

CE Declaration of conformity

Claber S.p.A.

Via Pontebbana 22 – 33080 – Fiume Veneto – Pordenone Italy

Assuming full responsibility, we declare that the product:

8428 - AQUAUNO VIDEO2 water timer

complies with European directives 2004/108 with reference to technical standards:

IEC EN 61000-6-1 :2007;

IEC EN 61000-6-3 :2007.

Fiume Veneto, 31/01/2015

CE 12

Certification Officer

Avv. Oliviano Spadotto

