

Aquadue DUPLLO Evolution



US
01

ES
27

FR
53



8420

claber®

US Table of contents

Introduction	3
Features	3
Operating controls	4
Operating tips	5
Battery installation.....	6-7
Installation on faucet	8
Display and keyboard.....	9
Programming.....	10-16
Setting current time and current day	10
Setting watering programs	11-13
Deleting programs.....	14
Weekly schedule	15
Default factory settings	16
Manual mode	17-18
Frequently asked questions	19-20
Trouble shooting.....	21
Routine maintenance	22
Parts blowout drawing	22-23
Warranty.....	24
Declaration of conformity.....	25

Introduction

We are pleased you have chosen the Aquadue Duplo Evolution water timer, model 8420. This Italian-made timer utilizes the most sophisticated technology and most durable material bringing you years of low maintenance and a worry-free lawn. Read instruction manual carefully before programming; save manual for future use.

If you have any questions regarding this water timer, please call our toll free customer service line at 800-930-4566 or email us at info@claberinc.com.

Features

The timer automatically waters two areas with different water requirements. The two outlets are programmable to release water up to three times a day on any or all days of the week, for duration ranging from 1 minute to 23 hours and 59 minutes total. The timer operates on one 9V Alkaline battery (not included); a battery power level indicator on the LCD display determines when battery should be replaced.

- Weekly function option; programs run on any or all days of the week.
- A manual override allows to water between cycles or to stop the on-going irrigation cycle without altering existing programs.
- Line A or Line B will stay open manually for a minimum of 15 minutes to a maximum of 60 minutes; time can be increased in 5 minutes increments only.
- Built-in stainless steel filter traps harmful contaminants.
- Programmed irrigation cycles and weekly watering days are retained while battery is removed.
- Quick-click connect couplings for fast and easy hose removal.
- Rain Sensor accessory available (sold separately; Claber model 90915).

Note: Every time the battery is re-inserted into the unit, current time and current day need to be checked and eventually set.

US Operating controls

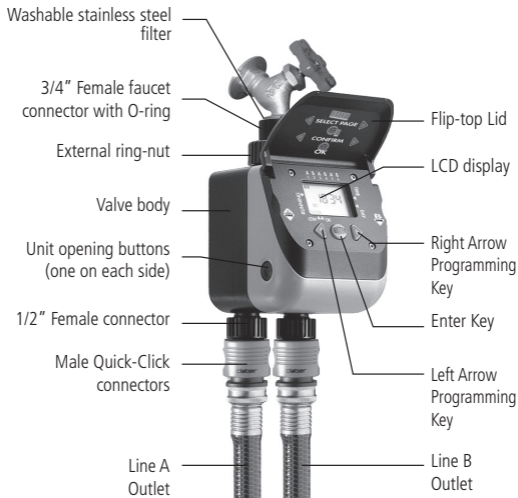

Operating tips

- The two lines do not operate simultaneously to maintain water flow rate; programs open consecutively starting from program 1.
- Weekly programming affects both lines.
- Manual mode is preset at a minimum of 15 minutes; longer time can be set in 5 minutes increments up to a maximum of 60 minutes.
- Use Alkaline batteries only; do not use lithium or rechargeable batteries.
- Install new battery at the start of the watering season.
- Regularly wash the filter to prevent clogging.
- Remove from faucet when temperature reaches below 37.4°F (3°C), drain all water and remove batteries to avoid oxidization.
- When using for the first time, observe the progress of the program/s to ensure the unit operates properly.
- Be careful when pulling the hose or fittings to prevent damage to the unit.
- Do not use with operating pressure below 7.3 PSI (0.5 Bar) or higher than 145 PSI (10 Bar) and with water temperature exceeding 104°F (40°C).
- Do not install into any type of valve box or under the soil level.
- Do not submerge in water or other liquids.
- Use with tap water only.
- Keep the flip-top lid closed when not programming to protect against outdoor elements.



- Keep out of reach of children and animals.
- Do not expose at temperature below 37.4°F (3°C).

US Battery installation



1. Press the two side buttons on the front panel then insert one new 9V Alkaline battery into the terminal.
2. Replace the battery back into the housing.
3. Battery power level indicator on the LCD display appears as: **BATTERY** full battery power, **BA** low battery power.

Notes:

First Time Users / Default Factory Settings:



➔ This is your starting screen.
For programming see pages 10-16.

Re-occurring Users:

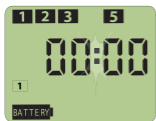

➔ Screen example after the battery has been re-installed.

- Retained programs (i.e. 1,2,3,5)
- Current time and current day have to be re-set (see page 10).

Battery installation

Notes:

- Use only Alkaline batteries.
- Battery power level indicator flashes when battery is running low: battery should be replaced.
- Replace the battery at the beginning of the watering season.
- Programmed irrigation cycles and weekly waterings days are retained while battery is removed.
- When timer is not in use for an extended period of time, remove the battery to avoid oxidization.



If battery dies during a watering cycle, unit will operate until the end of the scheduled program in progress. Once valve is closed, battery should be replaced.

US Installation on faucet

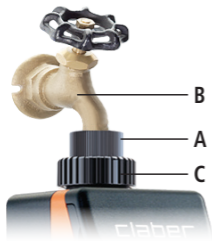

1. Loosen external ring-nut C.
2. Tighten 3/4" female connector A on faucet B.
3. Tighten external ring-nut C to timer housing.

Note:

It is easier to program the timer before attaching it to the faucet.



- Do not install into any type of valve box or under the soil level.
- Use with tap water only.
- Do not use with operating pressure below 7.3 PSI (0.5 Bar) or higher than 145 PSI (10 Bar) and with water temperature exceeding 104°F (40°C).

Display and keyboard

US

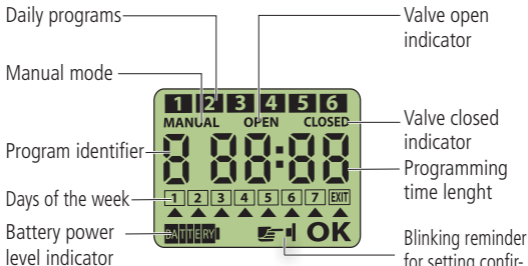

LEFT ARROW

Moves backward through the pages, displaying the programs and settings, as well as modifies the settings

ENTER

Accesses the page for modifying the settings with the arrows keys and confirm changes

RIGHT ARROW

Moves forward through the pages, displaying the programs and settings, as well as modifies the settings

US Programming



SETTING CURRENT TIME AND CURRENT DAY

Few seconds after the battery is connected, the display will show the clock page.

The two dots in the center blink when in operation.



1 Press **ENTER** (the **OK** icon will appear).

2 Use the two arrow Keys to: decrease ◀ or increase ▶ the time (holding down the arrow key will move through the clock faster).



3 Once the current time is set, press **ENTER** to access the page for setting the current day.



4 Use the two arrow Keys ◀ or ▶ to position the cursor ▲ below the current day knowing that:

1	2	3	4	5	6	7
SUN	MON	TUE	WED	THU	FRI	SAT



5 Press **ENTER** to confirm (the **OK** icon will disappear).

Note: Timer operates in military hours only (see page 20).



SETTING WATERING PROGRAMS

The Timer has two outlets for automatic watering of two independent zones up to six times a day.

Each line has three programs per day.



Programs 1,3,5 run on line A (left outlet).

Programs 2,4,6 run on line B (right outlet).

The timer works on a 24 hour clock (*i.e.* 2 pm = 14:00) therefore prior to setting the programs, make sure your scheduling falls within a 24 hour window.

Program 1 must correspond to your earliest watering cycle of the day because all following programs move forward in time from program 1.

(i.e. if program 1 is set up to start at 16:00 = 4 pm, there are 8 hours left in which the remaining programs can be set).





US Programming

SETTING OPENING TIME

1. Press  to display **PROGRAM 1** ^{OPEN}



program identifier
valve open indicator





2. Press  (the **OK** icon will appear).
3. Use the two arrow Keys to:
decrease  or increase  program time
(holding down the arrow key will move through the clock faster).
4. Press  (the **OK** icon will disappear)

Setting closing time

1. Press  to display **PROGRAM 1** ^{CLOSED}



program identifier
valve closed indicator

2. Press  (the **OK** icon will appear).
3. Use the two arrow Keys to:
decrease  or increase  program time.
4. Press  (the **OK** icon will disappear)

Follow the instructions as listed above to set watering times for all remaining programs.



**Programs 1,3,5 run on line A (left outlet).
Programs 2,4,6 run on line B (right outlet).**

Notes:

- When programming watering cycles, the time automatically adjusts by default to the next minute (*i.e. Program 1 closing time 07:30, Program 2 opening time defaults to 07:31*).
- All programs must be set in sequence, for example after setting program 1 it is not possible to set program 3 without having first set program 2. However it is possible to delete any program once that program has been set (see chapter Deleting programs at page 14).

US Programming

DELETING PROGRAMS

1. Use arrows keys to select the program you wish to delete, the display must be in the **CLOSED** option.
2. Press **ENTER** (the **OK** icon will appear).
3. Press **▶** first and while pressing this key, press **◀** until timer reads 00:00

CUSTOM PROGRAMMING EXAMPLE

If you require **single line programming** see example below:

STEP 1

Set all the programs on each line:

A	B	A	B	A	B
1	2	3	4	5	6

STEP 2

Delete the programs on the line you don't want to use:

A	B	A	B	A	B
1	2	3	4	5	6

In this case 3 programs (2,4,6) have been set for line B and no program on line A

If you require **more programs on one line than the other**, see example below:

STEP 1

Set all the programs on each line:

A	B	A	B	A	B
1	2	3	4	5	6

STEP 2

Delete the programs you don't want to use:

A	B	A	B	A	B
1	2	3	4	5	6

In this case 3 programs have been set for line B (2,4,6) and 1 program for line A (1)



Once programs are set (*i.e.* 1, 2, 3 and 5) they are visible by a numbered digital block on top of all pages.

Number corresponding to the program currently in operation flashes until program is over.

WEEKLY SCHEDULE

Weekly schedule effects both lines and all set programs.

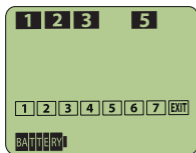

Use the two arrow Keys ◀ or ▶ to move through the pages until the display shows the weekly page where numbers from 1 to 7 represent the days of the week, as shown in the table below:

1	2	3	4	5	6	7
SUN	MON	TUE	WED	THU	FRI	SAT

How to enable or disable a day of the week for automatic watering:

1. Press **ENTER** (the **OK** icon will appear).
2. Use the two arrow Keys ◀ or ▶ to move ▲ below the location of the desired day.
3. Press **ENTER** one or more times until the corresponding day number appears for the day to be a "watering day" or disappears for the day to be a "not watering day".
4. Once the weekly schedule has been completed move ▲ below **EXIT** then press **ENTER**.

US Programming

DEFAULT FACTORY SETTINGS



To completely restore the default factory settings press the two arrow Keys ◀ and ▶ for approximately 5 seconds until 00:00 is shown on the display.

Manual mode

The manual mode allows the following:

- to **open** Line A or Line B for a minimum of 15 minutes to a maximum of 60 minutes. Automatic operation of the other Line is not affected.
 - to **close** an ongoing automatic watering on Line A or Line B.
- When exiting the manual mode, programmed watering will be resumed only when scheduled to start again.

Note: Preset programs are not altered during manual operations.

Entering Manual mode:

1. To open Line A or Line B use the two arrow Keys ◀ and ▶ until the MANUAL A page or the MANUAL b page is shown:

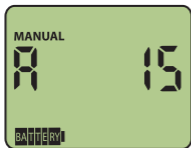

LINE A

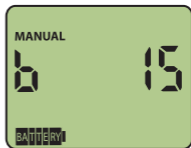

LINE B

2. Press **ENTER** (the **OK** icon will appear).
3. Press ◀ to open the valve (**OPEN** will appear): the minimum preset time of 15 minutes appears. At any time while the manual mode is in operation, it is possible to extend the manual watering by pressing the ◀ key; each pressure of the ◀ key adds 5 minutes to the time left.
4. Press ▶ to close the valve (**CLOSED** will appear): water stops flowing.

US Manual mode

5. Exiting Manual mode is possible only when the selected Line is CLOSED:
1. by pressing OK;
 2. after a few minutes the timer will automatically go back to the current time page.

Notes:

- If the manual mode is selected for a line in which a watering program is running, automatic operation stops but water continues to flow until the manual mode is complete. Program is maintained and will resume as programmed.
- A program scheduled to open a Line currently selected in manual mode, will not start.
- A program that is stopped or prevented from starting will resume normal operation only when scheduled to start again.
- If valve is not closed by using , the line will automatically close when the manual time left has expired.

Frequently asked questions

Why can't unit automatically water from both lines at the same time?

Having both lines operating simultaneously water flow would be too low and the pressure not sufficient for proper operation of the hose end applications. Only exception is when in manual mode (see page 17).

Can the programs be scheduled to operate over midnight?

No, all programs must be set within a 24 hour window starting from midnight = 00:00.

Can the two lines have different weekly programs?

No; weekly programming effects both lines.

Can I use any 9V battery?

No, Alkaline only. Do not use lithium or rechargeable batteries.

Can I change the 15 minute of the manual mode?

Yes, the time can be increased in 5 minutes increments up to a maximum of 60 minutes.

Once started, the manual mode can be stopped by hand before the time left for watering has elapsed.

What happens if the unit is not removed during freezing temperature?

The ABS plastic components will crack causing the unit to be inoperable. Product will not be warranted under this circumstance.

US Frequently asked questions

How do I determine the time in military hours?

Use chart below as a reference:

REGULAR TIME											
noon	01:00 PM	02:00 PM	03:00 PM	04:00 PM	05:00 PM	06:00 PM	07:00 PM	08:00 PM	09:00 PM	10:00 PM	11:00 PM
↓	↓	↓	↓	↓	↓	↓	↓	↓	↓	↓	↓
12:00	13:00	14:00	15:00	16:00	17:00	18:00	19:00	20:00	21:00	22:00	23:00
MILITARY TIME											

How much water is delivered per minute?

Use chart below as a reference; chart is based on timer being tested at different PSI levels.

PSI							
7,3	10	15	30	40	50	60	80-145
↓	↓	↓	↓	↓	↓	↓	↓
3,7	4,2	4,8	6,4	7,6	8,1	8,3	9,0
Gallon/minute							

Trouble shooting

US

PROBLEM	SOLUTION
The unit is not working according to the programs set	Verify the valves open/close when in manual mode (see "Manual mode" on page 17-18)
	Verify program(s) are set from the earliest to the latest time of day, based on military hours (see "Setting watering programs" on page 11-13).
	Verify that all week days have not been eliminated from the weekly programming page (see "Weekly schedule" on page 15).
	Verify that solenoid valve wires are inserted into correct outlets inside orange face plate as well as verify Rain Sensor circuit wire has not been removed.
The display does not turn on after inserting the battery	Disconnect the battery and reattach by pressing firmly the terminal with the palm of your hand.
	Disconnect the battery and press all three programming keys for 1 minute. Reconnect the battery, then follow programming procedures (see pages 10-16).
When battery is inserted, LCD screen is jumbled and irregular	Alkaline batteries are to be used; lithium or rechargeable batteries will not work.
There is leaking from faucet connection	Clean stainless steel filter with water only.
	Check that the O-ring located in the 3/4" Female faucet connector is not missing.
	Filter must be in-line with water and the external ring nut tightened.

US Routine maintenance

- Clean impurities inside and outside the unit.
- Check that all wires are in good condition.
- Very carefully, disassemble the valve case and clean dirty areas with water only. When reassembling, make sure that valve wires are in the upward position and the white side of the magnet is in the upfront position. The entire operation requires extreme care to avoid damage and to maintain warranty coverage.

Note: Depending on how hard/dirty water build-up is, the solenoid valve may need to be replaced.

Parts blowout drawing

Description

- | | |
|---------------------------------|--|
| 1. 1-1/4" External ring-nut | 11. Rain Sensor jumper |
| 2. Stainless steel filter | 12. Screw M4x8 |
| 3. 3/4" Female faucet connector | 13. Spacer for solenoid |
| 4. NBR O-ring | 14. Bracket |
| 5. Valve body | 15. Solenoid with upward cable* |
| 6. O-ring | 16. Screws (x4) for magnet flange |
| 7. 1/2" Female connector | 17. Magnet group with bushing and flange** |
| 8. Control panel | 18. Piston |
| 9. Flip-top lid | 19. Membrane valve |
| 10. 9V Battery wire connectors | |

* wire cable must be UPWARD

** white side of the magnet must be UPFRONT

Parts blowout drawing

US

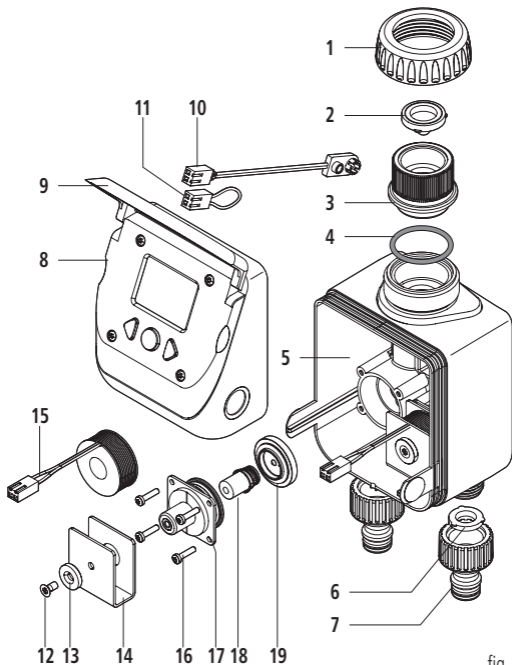

fig. 1

US Warranty

Product is warranted for a period of 2 years from date of purchase with proof of purchase receipt. Claber, at its own discretion, will repair or replace defective parts or unit if operated under normal working conditions.

Warranty will not be extended on product or parts resulting in operation misuse, alterations, neglect, abuse, improper installation or normal wear and tear. Claber shall not be liable for damage on products manufactured by other companies when combined in use.

Claber, at its own discretion, may require product or parts to be returned to the Warranty Department. All shipping charges and risks are incurred by customer. If coverage is found, product or parts will be repaired or replaced. Please allow 3-4 weeks to process return. All repairs or replacements are warranted only for the remainder of original warranty period, started at date of purchase. Charges may incur if warranty coverage is not applicable.

To ensure warranty coverage, serial number (*i.e.* 986 1383, located inside orange face plate identified by 6 or 7 digit code) and a copy of sales receipt should be sent within 30 days after purchase in one of the following ways:

1. MAIL

Claber, Inc
191 Stanley Street
Elk Grove Village, IL 60007

WRITE THE SERIAL NUMBER

--	--	--	--	--	--	--	--

2. FAX

Fax: 847.364.4588

3. EMAIL

info@claberinc.com

Please note that if above information is not on file at time of contact, this may cause delay or refusal of warranty fulfillment. For any further information on customer assistance, you may contact Claber Inc. at toll free 1-800-930-4566.

CE Declaration of conformity

US

Claber S.p.A.

Via Pontebbana, 22 - 33080 - Fiume Veneto - Pordenone - Italy

We hereby declare under our full responsibility that this product:

8420 - Aquadue Duplo Evolution

conforms to European Directive 2004/108/CE

With reference to the technical standards defined under EN61000-6-1:2007 (immunity) and EN61000-6-3:2007 (emissions).

Fiume Veneto, 10/10/2013

CE 2013

Conformity Manager

Avv. Spadotto

